

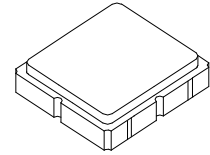

Preliminary

SF1183E_TD

881.5 MHz
SAW Filter



SM3030-6

- RF Filter for Mobile Communication Applications
- Low Insertion Loss
- 3.0 x 3.0 x 1.3 mm Surface-mount Case
- No Matching Circuit Required

Absolute Maximum Ratings

| Rating | Value | Units |
|---------------------------------------|-----------------|-------|
| Maximum Input Power | +10 | dBm |
| Maximum DC Voltage | 5 | VDC |
| Component Operating Temperature Range | -30 to +85 | °C |
| Component Storage Temperature Range | -40 to +85 | °C |
| Max Soldering Profile | 265 °C for 10 s | |

Electrical Characteristics

| Characteristic | Sym | Notes | Min | Typ | Max | Units |
|---|-------|---------|-----|-------|-------|----------|
| Nominal Operating Frequency | f_c | 1 | | 881.5 | | MHz |
| Insertion Loss, 869 to 894 MHz | IL | | | 2.3 | 3.0 | dB |
| Amplitude Ripple, p-p, 869 to 894 MHz | | | | 0.8 | 1.5 | |
| Attenuation (Reference level from 0 dB) | | | | | | |
| DC to 824 MHz | | 1, 2, 3 | 40 | 50 | | dB |
| 824 to 849 MHz | | | 35 | 47 | | |
| 970 to 997 MHz | | | 35 | 64 | | |
| 997 to 1150 MHz | | | 40 | 60 | | |
| 1150 to 1500 MHz | | | 30 | 51 | | |
| 1500 to 2000 MHz | | | 25 | 41 | | |
| 2000 to 3000 MHz | | | 20 | 27 | | |
| VSWR, 869 to 894 MHz | | | | 1.6:1 | 2.0:1 | MHz |
| Source impedance | Z_S | | | 50 | | Ω |
| Load impedance | Z_L | | | 50 | | Ω |

| | |
|--|---|
| Single Ended Input / Output, Impedance match | No matching network required for operation at 50 ohms |
| Case Style | SM3030-6 3 x 3 mm Nominal Footprint |
| Lid Symbolization (Y=year, WW=week, S=day) | A92 YWWS |

Electrical Connections

| Connection | Terminals |
|------------|------------|
| Input | 2 |
| Output | 5 |
| Ground | All others |

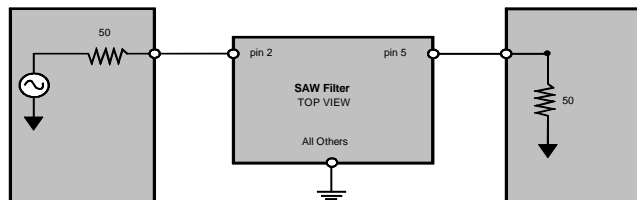

Notes:

1. Unless noted otherwise, all specifications apply over the operating temperature range with filter soldered to the specified demonstration board with impedance matching to 50 Ω and measured with 50 Ω network analyzer.
2. Unless noted otherwise, all frequency specifications are referenced to the nominal center frequency, f_c .
3. Rejection is measured as attenuation below the minimum IL point in the passband. Rejection in final user application is dependent on PCB layout and external impedance matching design. See Application Note No. 42 for details.
4. "LRIP" or "L" after the part number indicates "low rate initial production" and "ENG" or "E" indicates "engineering prototypes."
5. The design, manufacturing process, and specifications of this filter are subject to change.
6. Either Port 1 or Port 2 may be used for either input or output in the design. However, impedances and impedance matching may vary between Port 1 and Port 2, so that the filter must always be installed in one direction per the circuit design.
7. US and international patents may apply.
8. RFM, stylized RFM logo, and RF Monolithics, Inc. are registered trademarks of RF Monolithics, Inc.
9. Electrostatic Sensitive Device. Observe precautions for handling.



Filter Frequency Response Plots

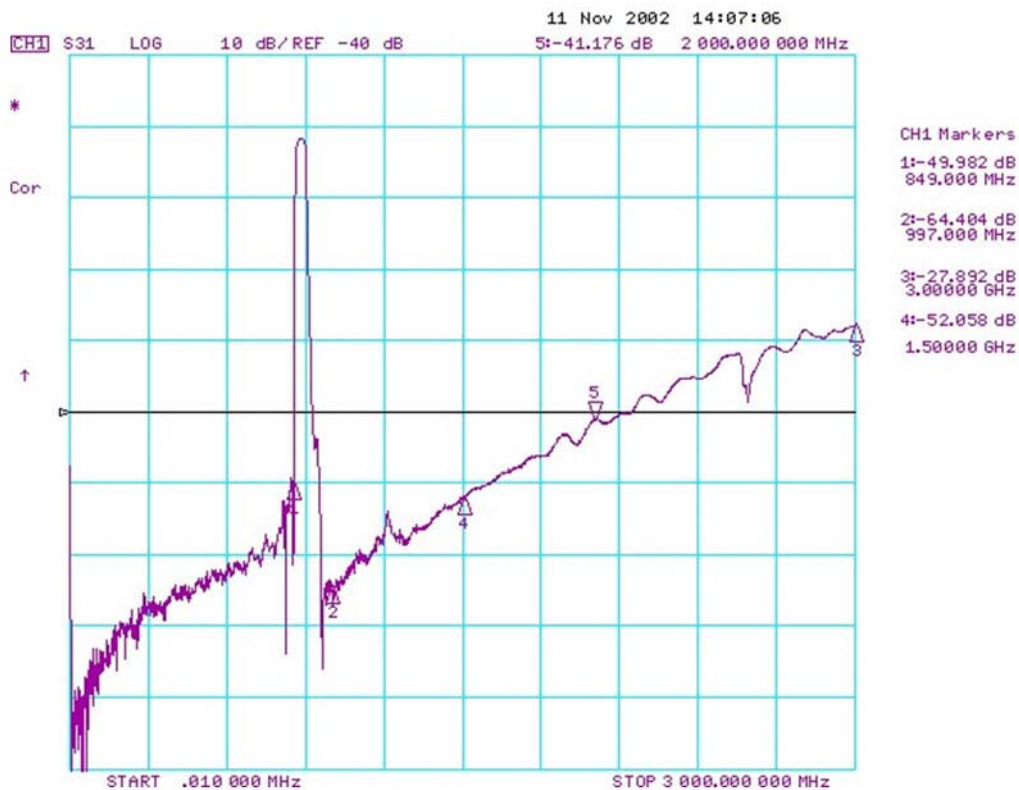
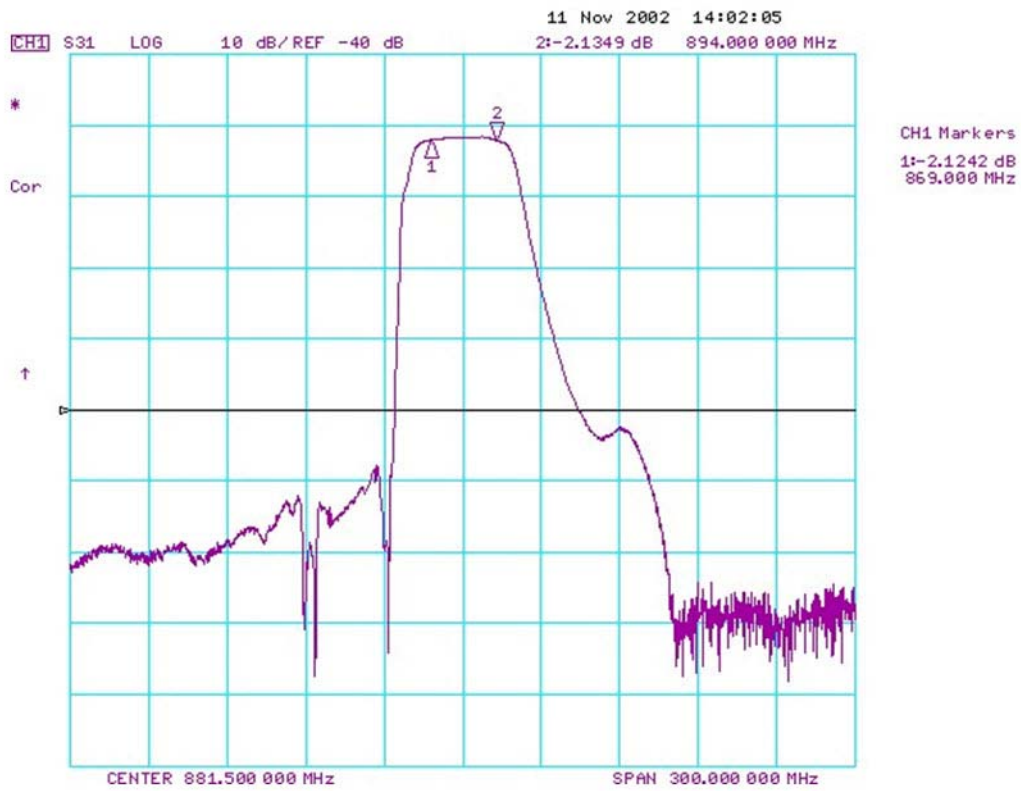

VSWR and Impedance Plots

S11

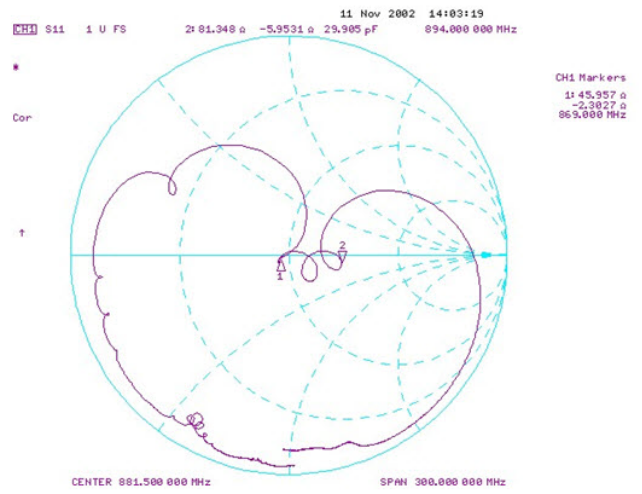
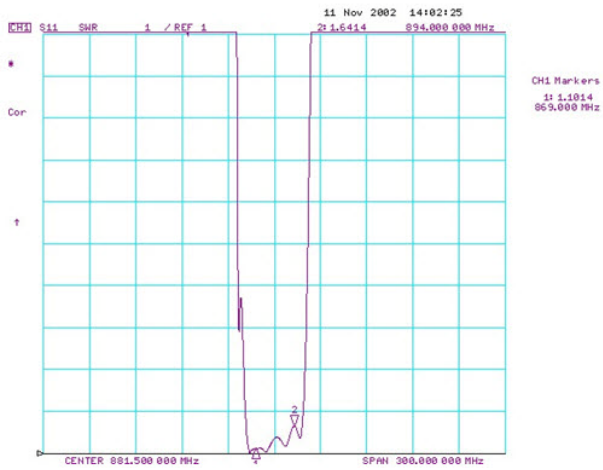

S22

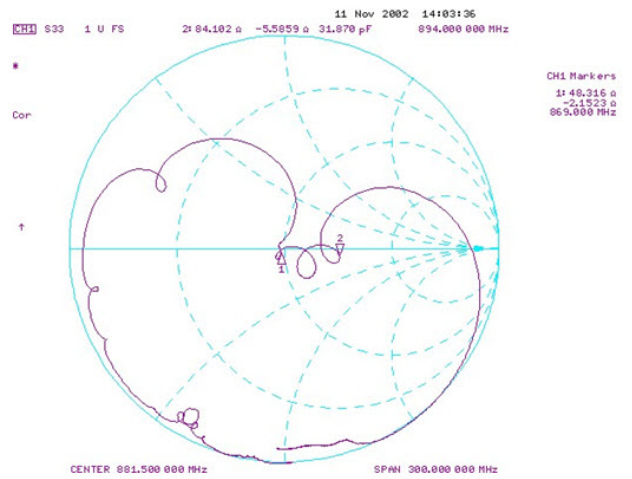
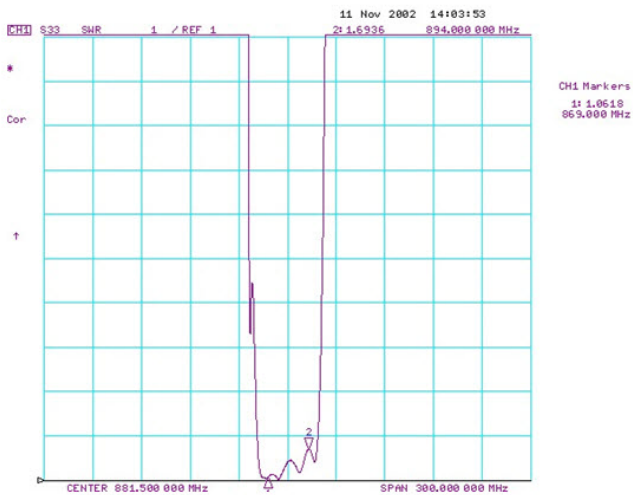

Tape and Reel Specifications

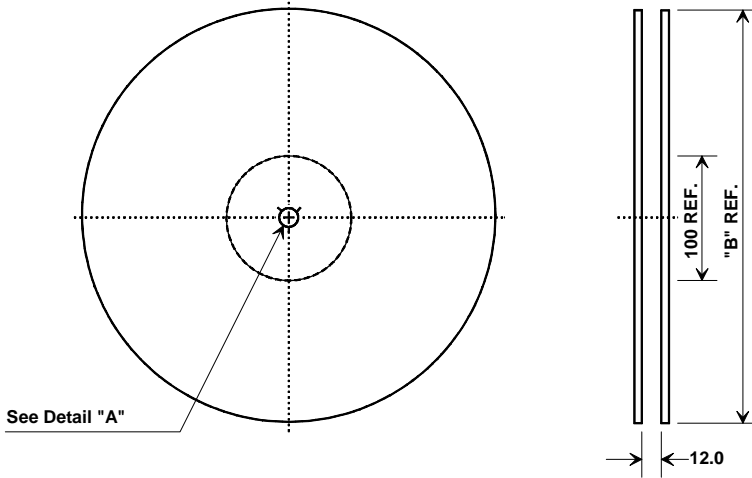

| "B" | | Quantity Per Reel |
|--------|-------------|-------------------|
| Inches | millimeters | |
| 7 | 178 | 500 |
| 13 | 330 | 2000 |

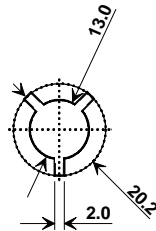

COMPONENT ORIENTATION

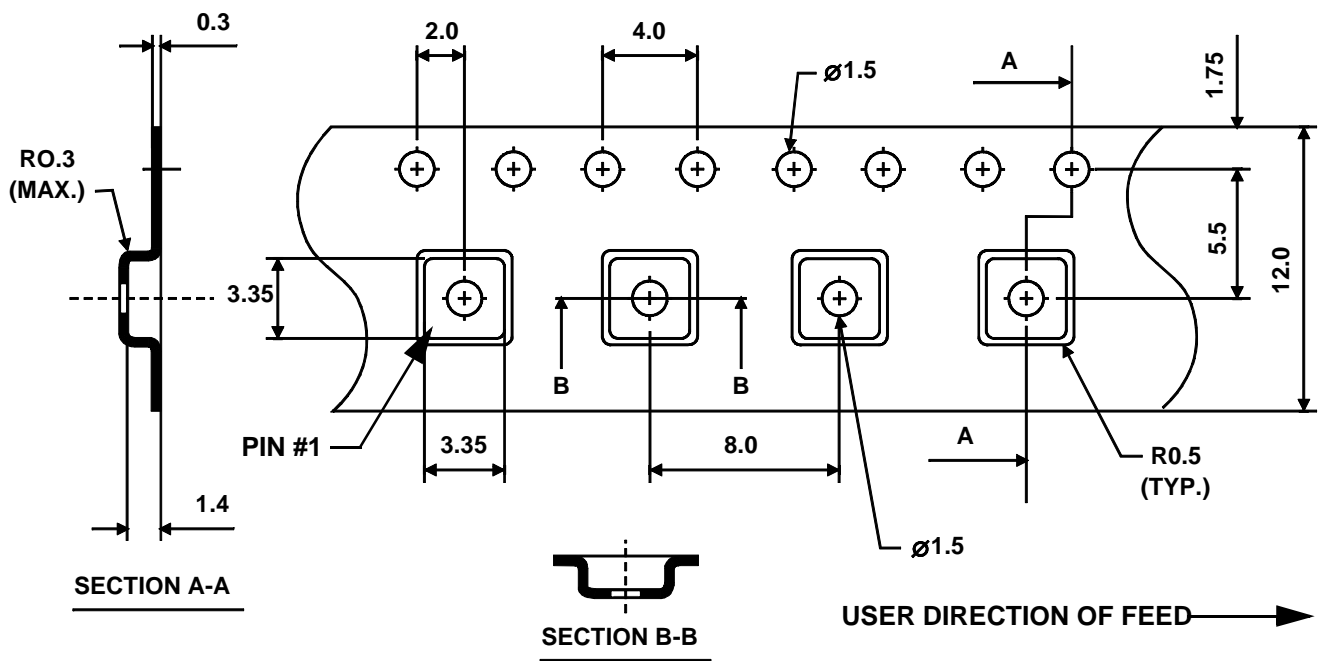

SM3030-6 Case

6-Terminal Ceramic Surface-Mount Case 3.0 X 3.0 mm Nominal Footprint

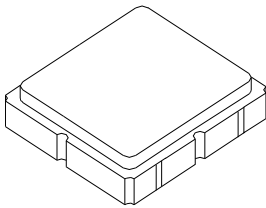

Case Dimensions

| Dimension | mm | | | Inches | | |
|-----------|-----|------|-----|--------|-------|-----|
| | Min | Nom | Max | Min | Nom | Max |
| A | | 3.0 | | | 0.118 | |
| B | | 3.0 | | | 0.118 | |
| C | | 1.3 | | | 0.051 | |
| D | | 0.9 | | | 0.035 | |
| E | | 2.54 | | | 0.100 | |
| F | | 1.6 | | | 0.063 | |
| G | | 0.85 | | | 0.033 | |
| H | | 1.5 | | | 0.059 | |
| I | | 0.6 | | | 0.024 | |
| J | | 1.3 | | | 0.051 | |

Electrical Connections

| Connection | | Terminals |
|------------------------------------|---------------------|------------|
| Port 1 | Single Ended Input | 2 |
| Port 2 | Single Ended Output | 5 |
| | Ground | All others |
| Single-ended Operation Only | | |
| Dot indicates Pin 1 | | |

TOP VIEW

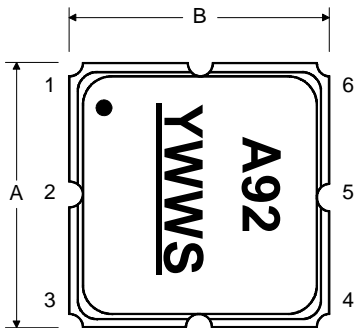

BOTTOM VIEW

